

NEW

A safe, flexible and advanced technology solution for handling long and heavy objects

# eRTG

Rubber Tyred Gantry Crane



**ElectroMech**

| Solutions | Service | Satisfaction |

# eRTG

Rubber Tyred Gantry Crane

**A safe, flexible and advanced technology solution for handling long and heavy objects**

## **About ElectroMech**

We have been serving customers across the world for over 40 years with safe, customised and perfectly engineered overhead crane solutions. We are one of the leading industrial crane manufacturers in the region and have significant presence across 60 countries. Over the years, we have earned the trust of our customers as a reliable partner for providing solutions to their material handling challenges through our vast range. This has led us to add a new dimension to our range and we are proud to introduce eRTG – Rubber Tyred Gantry crane for the world market.

**Legacy of 4 decades**

**Area of 120,000sq.m**

**750 employees globally**

**Over 10000 solutions globally**

**65% repeat customers**



### **Gradeability**

Up to 5%

### **Intact floor**

Constant pressure on floor irrespective of amount of load lifted

### **Versatility**

Capability to work on various surfaces

### **Portability**

Can be easily disassembled and transported

### **Low cost of ownership**

Low maintenance, high uptime, high productivity, low expenses on developing infrastructure

### **Electrically driven**

No hydraulics involved  
(No power supply, runway needed)

### **High safety**

Safe handling of long, heavy and odd-shaped items

### **Reliability**

Proven technology equipment from ElectroMech with assured service support

### **Turns effortlessly**

Can easily negotiate turns

### **Flexibility**

Can be operated on uneven surfaces

### **Robust structure**

Designed for dynamic loads



## **About RTG**

Rubber Tyred Gantry crane, popularly known as RTG the world over, is a tyre-mounted gantry crane, which can be moved anywhere easily – across large outdoor yards, workshops or factories.

Being tyre-mounted, it does not require permanently fixed rails, which means extreme flexibility in movement across the shop or yard area. ElectroMech is the first company in India to indigenously develop steerable electrically-operated RTG.



### Bolted Design

For easy assembly, dismantling & transportation



### Trolley & Hook Block

Sturdy design with anti-friction bearings mounted sheaves and wheels



### Robust Structure

Designed for dynamic loads



### Steering of Tyres

Flexibility to move in various directions



### Self Propelling

Diesel Generator on crane as power source (No separate power supply required)

### Control Panel

All motions controlled through Variable Frequency Drive (VFD) & PLC

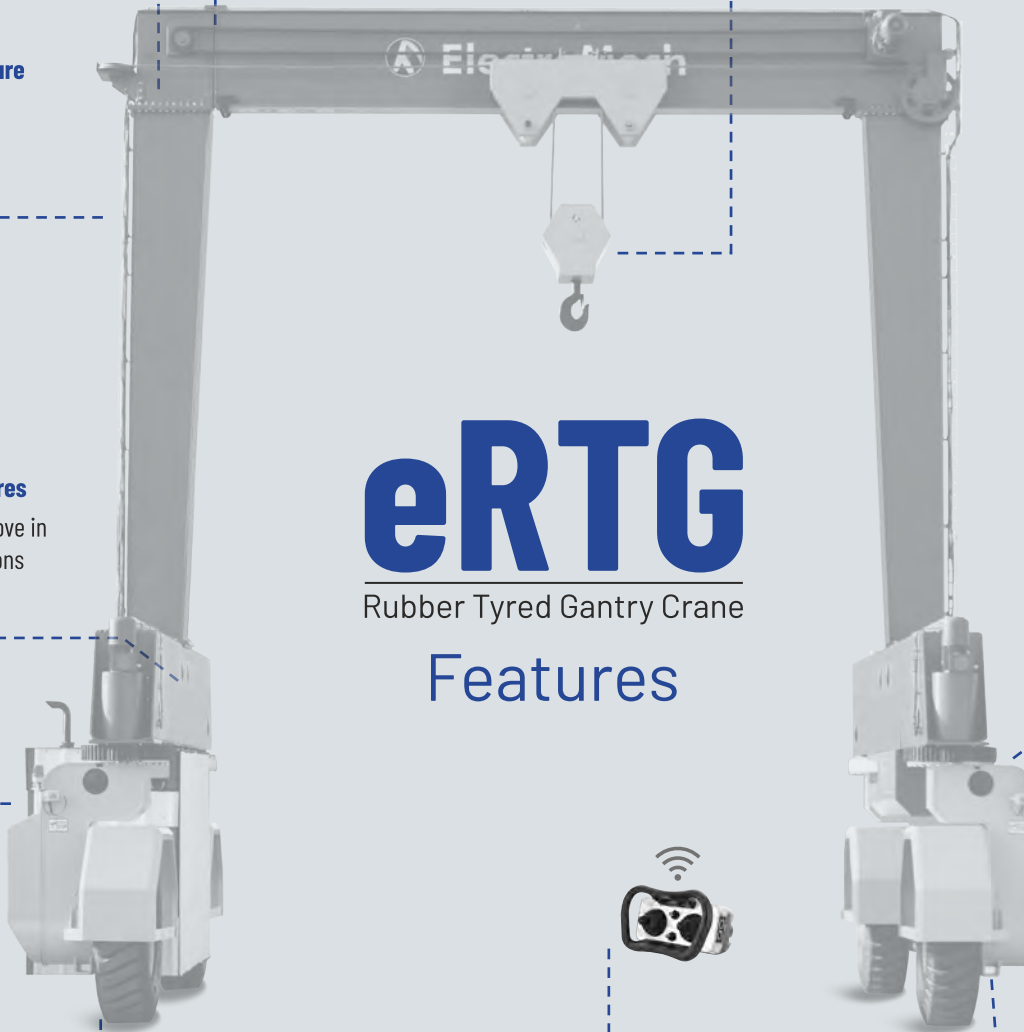

# eRTG

Rubber Tyred Gantry Crane

## Features

### Tyre-mounted

Pneumatic tubeless tyres. Can work effectively on uneven surfaces with shock absorbing ability.

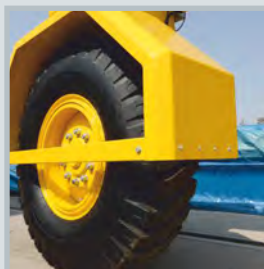

### Remote-controlled

All operations are controlled via radio remote device for operators' safety and load visibility.

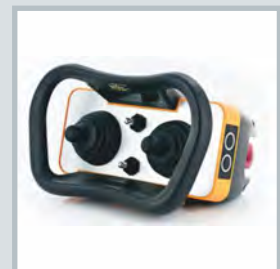



### Structural Flexibility

Makes it possible to travel over uneven surfaces with gradient



### Ease of Access

Major components can be accessed easily for maintenance



### Emergency Stop

Installed at each corner to ensure operator safety during crane operation



### Jacking Provision

For easy replacement and fixing of tyres within a short time

## Working of eRTG and constructional features

eRTG is an innovative material handling solution making lifting and handling operations safe across a range of industries.

- Self-propelled equipment driven by electric motors with VFD controllers ensures optimised power consumption.
- Inbuilt controls using Steering Geometry Intelligence make it easy to negotiate turns just like any other automobile.
- Designed to operate on gradients and various other surfaces adds the all-important feature of flexibility required in material handling equipment.
- The rigid structure is designed to take dynamic loads, making it sturdier and safer.
- Components can be easily accessed for routine maintenance.
- Can be easily assembled and disassembled for quick relocation.

eRTG from ElectroMech is an innovative solution for your material handling requirements to move loads easily in all directions and on various surfaces. These features make it the perfect choice for industrial, infrastructure, wind energy and other sectors to competently address various load-handling challenges.

### Tandem operational eRTG cranes

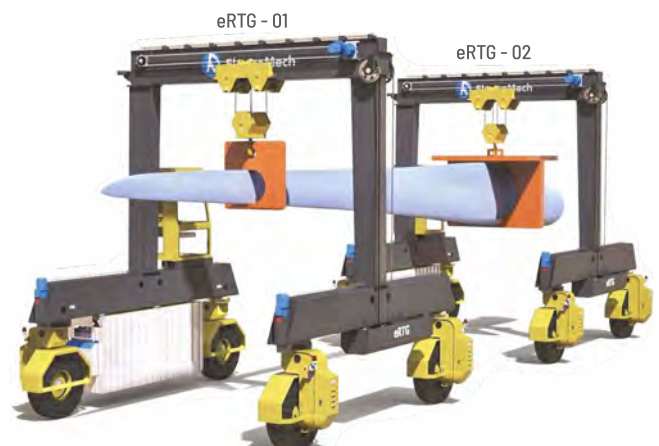

## Dimensions - eRTG

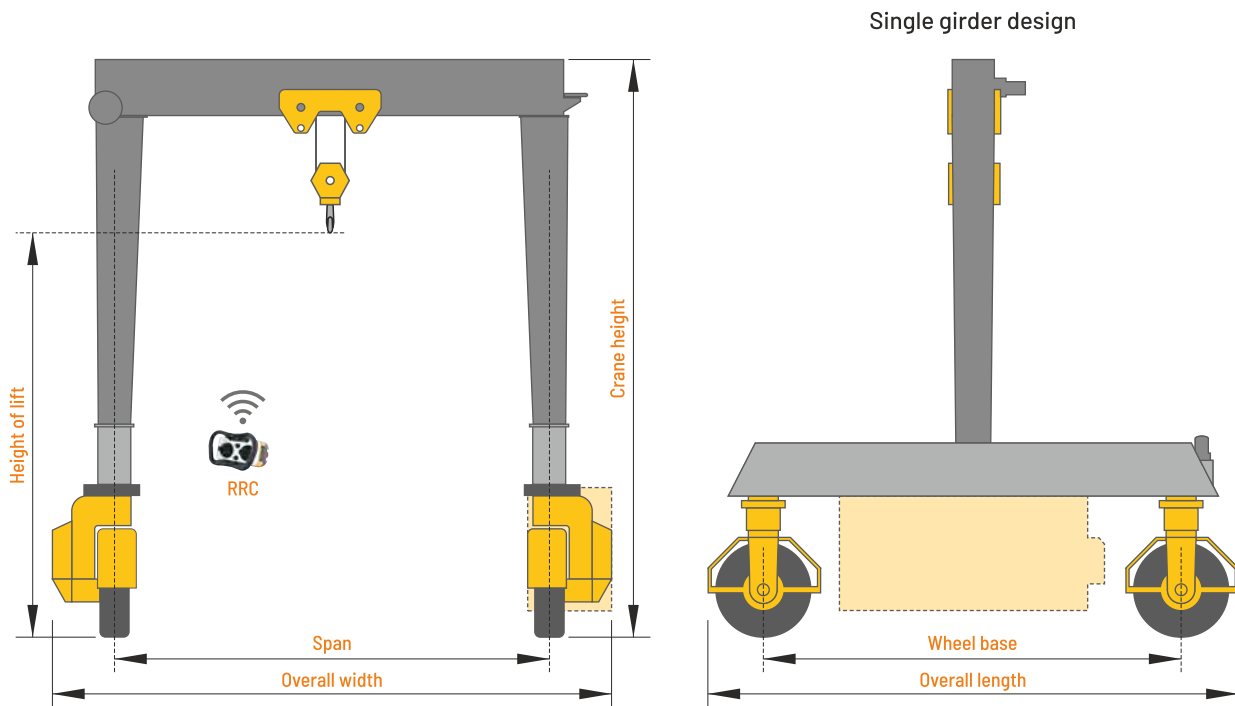

\*Span & height can be customised to suit requirement.

## Technical specifications - eRTG

SWL (Safe Working Load)	20t	32t	63t	80t / 100t / 150t / 200t
Design type	Single girder		Double girder	
Span	6m to 8m			Other parameters on request
HOL (Height Of Lift)	6m to 8m	7m to 10m		
Wheel base	Suitable for span			
Hoisting speed (Using VFD)	2 to 3m/min			
Long travel speed (Using VFD)	25 to 40m/min			
Cross travel speed (Using VFD)	10 to 15m/min			
Power source	Diesel generator mounted on crane			
Steering	Two Wheel Steering (2WS)			
Gradeability	Up to 5%		Up to 3%	
Operation control	Radio Remote Control			
Tyre	Pneumatic tubeless tyres			

### Standard features

- Travel warning alarms (4 nos.)
- 'Emergency stop' button at each corner
- Fire extinguisher
- Jacking provision for tyre removal

### Optional items

- Operator cabin control
- Battery-powered crane
- 'EMote' for remote monitoring of equipment
- Load indicator
- Customised span and height
- Four Wheel Steering (4WS)
- TPMS (Tyre Pressure Monitoring System)
- Gradient limiter

Double girder design

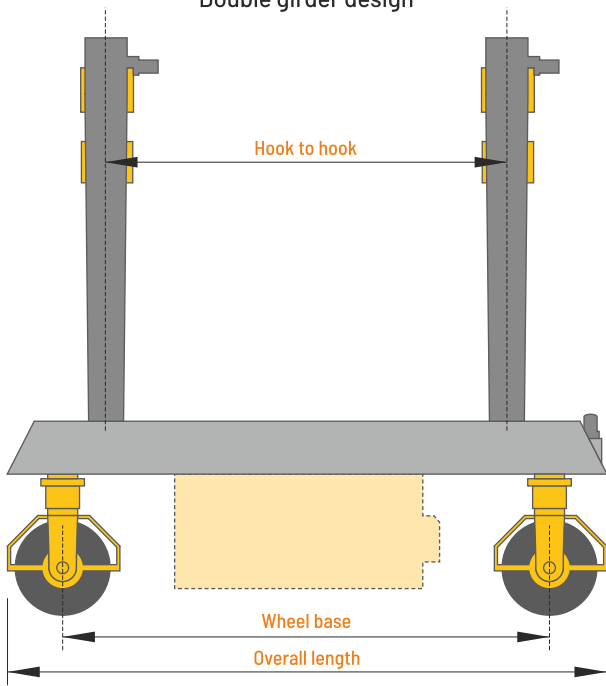

2 - Wheel Steering (2WS)

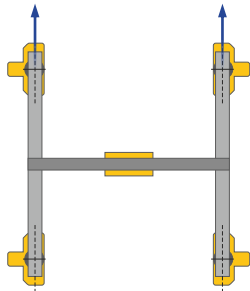

Straight line movement

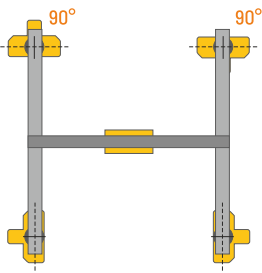

**P** Parking position

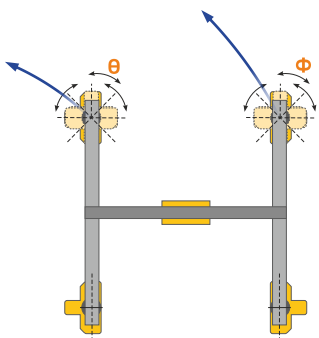

Taking a turn at any variable radius with its Steering Geometry Intelligence

4 - Wheel Steering (4WS)

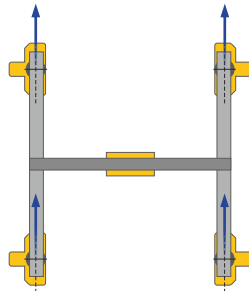

Straight line movement

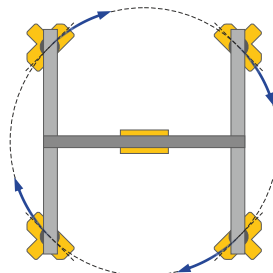

Polar movement (carousel)

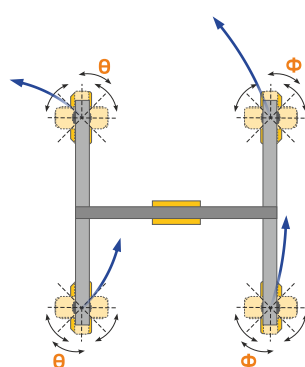

Taking a turn at any variable radius with its Steering Geometry Intelligence

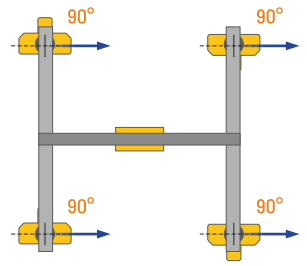

90° movement (1<sup>st</sup> direction)

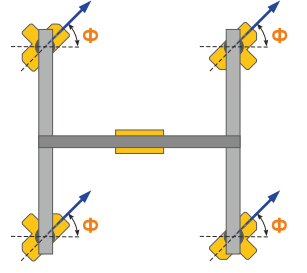

Diagonal movement (crab)

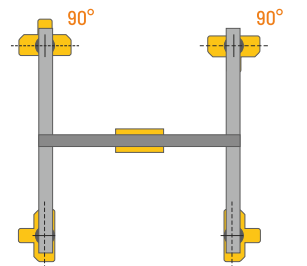

**P** Parking position

# Sectors that can benefit by using eRTG

Rubber Tyred Gantry cranes are the ideal choice for various infrastructure construction projects where flexibility in material handling is important. They can be used to handle various objects, such as precast segments, steel structures, pipes, concrete slabs, etc.

Besides construction projects, eRTGs are useful in several other industries. For example, in the wind energy sector, eRTG is ideal for handling tower sections, wind blades and turbines. In the process equipment manufacturing industry, eRTG is helpful in transporting equipment to storage yards and further loading it on to the trailers.

eRTG is useful where the terrain is not suitable to install gantry cranes or where temporary facilities are being used.

Coil handling



Pipe handling



Precast segment



Windmill tower



Windmill blade

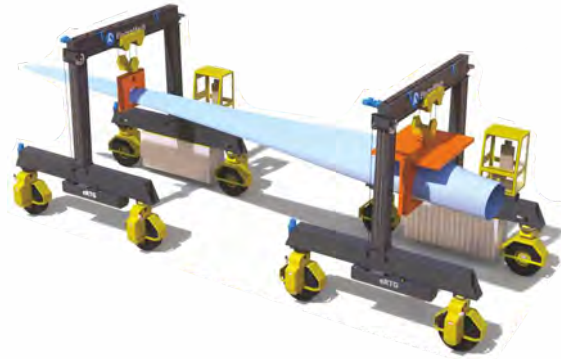

### ElectroMech Material Handling Systems (India) Pvt. Ltd.

Gat No. 316, At post Kasar Amboli, Tal. Mulshi, Dist. Pune 412 115 INDIA  
 Telefax: +91-20-6654 2222  
 E-mail: cranes@emech.in

### ElectroMech FZE

LOB 19 1002, P. O. Box 263019, Jebel Ali Free Zone, Dubai, UAE  
 Tel.: +971-4-8857466  
 Fax: +971-4-8857655  
 E-mail: contactus@emech.ae

### Pt. ElectroMech Manufacturing Industries

Jl. Jati Raya Blok J 10 No. 01B, Newton Techno Park, Desa Serang, Cikarang Selatan, Kab. Bekasi, Jawa Barat 17530, Indonesia  
 Tel.: +62 21 899 23111  
 E-mail: contactus@emech.id

### Electro Mech Equipment Trading LLC

Shop No. 8, Sector No. 44, Plot No. 13, Mussafah Industrial Area, Abu Dhabi, UAE  
 Tel.: +971-2-5588035  
 Fax: +971-2-5588235  
 E-mail: contactus@emech.ae



## ElectroMech

| Solutions | Service | Satisfaction |

KSA Office

### ElectroMech Industry Company

P.O Box 10034, Jubail 31961, Eastern Province, Kingdom of Saudi Arabia

Tel.: +966 503898671  
 +966 535897773

E-mail: contactus@emech.sa

Manufacturing Facilities & Offices



India



Indonesia



Saudi Arabia



UAE

Factory : Jubail

Offices : Al Khobar | Jeddah | Riyadh



[www.emech.sa](http://www.emech.sa)

follow us on:

© Copyright 2022 | All names, logos and monograms used in this brochure are registered trademarks of respective companies.

Technical changes reserved.